

ETA-Danmark A/S
Göteborg Plads 1
DK-2150 Nordhavn
Tel. +45 72 24 59 00
Fax +45 72 24 59 04
Internet www.etadanmark.dk



Authorised and notified according to
Article 29 of the Regulation (EU)
No 305/2011 of the European
Parliament and of the Council of 9
March 2011

MEMBER OF EOTA

European Technical Assessment ETA-08/0183 of 2018/09/06

I General Part

Technical Assessment Body issuing the ETA and designated according to Article 29 of the Regulation (EU) No 305/2011: ETA-Danmark A/S

Trade name of the construction product:

BB Angle Bracket 70 with and without rib
BB Angle Bracket 90 with and without rib
BB Angle Bracket 105 with and without rib

Product family to which the above construction product belongs:

Three-dimensional nailing plate (angle bracket for wood to wood connections)

Manufacturer:

BB Stanz- und Umformtechnik GmbH
Nordhäuser Str. 44
D-06536 Berga
Tel. +49 34651 2988 0
Fax +49 34651 2988 20
Internet www.bb-berga.de

Manufacturing plant:

BB Stanz- und Umformtechnik GmbH
Nordhäuser Str. 44
D-06536 Berga

This European Technical Assessment contains:

26 pages including 2 annexes which form an integral part of the document

This European Technical Assessment is issued in accordance with Regulation (EU) No 305/2011, on the basis of:

Guideline for European Technical Approval (ETAG) No. 015 Three Dimensional Nailing Plates, April 2013, used as European Assessment Document (EAD).

This version replaces:

The ETA with the same number issued on 2013-06-19 and expiry on 2018-06-19

Translations of this European Technical Assessment in other languages shall fully correspond to the original issued document and should be identified as such.

Communication of this European Technical Assessment, including transmission by electronic means, shall be in full (excepted the confidential Annex(es) referred to above). However, partial reproduction may be made, with the written consent of the issuing Technical Assessment Body. Any partial reproduction has to be identified as such.

II SPECIFIC PART OF THE EUROPEAN TECHNICAL ASSESSMENT

1 Technical description of product and intended use

Technical description of the product

BB Angle Bracket Type A70, 90 and 105 with and without rib are one-piece non-welded, face-fixed angle brackets to be used in timber to timber connections. They are connected to the timber elements by a range of profiled nails.

The angle brackets are made from pre-galvanized steel S 250 GD + Z 275 according to EN 10346 and are available with or without an embossed rib. Dimensions, hole positions and typical installations are shown in Annex A. BB angle brackets are made from steel with tolerances according to EN 10143.

2 Specification of the intended use in accordance with the applicable EAD

The angle brackets are intended for use in making connections in load bearing timber structures, as a connection between a beam and a purlin, where requirements for mechanical resistance and stability and safety in use in the sense of the Basic Works Requirements 1 and 4 of Regulation (EU) 305/2011 shall be fulfilled.

The connection may be with a single angle bracket or with an angle bracket on each side of the fastened timber member (see Annex A).

The static and kinematic behaviour of the timber members or the supports shall be as described in Annex B.

The wood members can be of solid timber, glued laminated timber and similar glued members, or wood-based structural members with a characteristic density from 290 kg/m³ to 420 kg/m³. This requirement to the material of the wood members can be fulfilled by using the following materials:

- Structural solid timber classified to C14-C40 according to EN 338 / EN 14081,
- Glulam classified to GL24-GL36 according to EN 1194 / EN 14080,
- LVL according to EN 14374,
- Parallam PSL,
- Intrallam LSL,
- Duo- and Triobalken,

- Layered wood plates,
- Plywood according to EN 636

Annex B states the load-carrying capacities of the angle bracket connections for a characteristic density of 350 kg/m³. For timber or wood based material with a lower characteristic density than 350 kg/m³ the load-carrying capacities for angle brackets from steel with thickness 2,5 mm shall be reduced by the k_{dens} factor:

$$k_{\text{dens}} = \left(\frac{\rho_k}{350} \right)^2$$

For angle brackets from steel with thickness 1,5 mm the load-carrying capacities shall be reduced by the k_{dens} factor:

$$k_{\text{dens}} = \left(\frac{\rho_k}{350} \right)^{0,8}$$

Where ρ_k is the characteristic density of the timber in kg/m³.

The design of the connections shall be in accordance with Eurocode 5 or a similar national Timber Code. The wood members shall have a thickness which is larger than the penetration depth of the nails into the members.

The angle brackets are primarily for use in timber structures subject to the dry, internal conditions defined by service class 1 and 2 of Eurocode 5 and for connections subject to static or quasi-static loading.

The angle brackets may also be used for connections between a timber member and a member of concrete or steel.

The provisions made in this European Technical Assessment are based on an assumed intended working life of the hold downs of 50 years.

The indications given on the working life cannot be interpreted as a guarantee given by the producer or Assessment Body, but are to be regarded only as a means for choosing the right products in relation to the expected economically reasonable working life of the works.

3 Performance of the product and references to the methods used for its assessment

Characteristic	Assessment of characteristic
3.1 Mechanical resistance and stability*) (BWR1)	
Characteristic load-carrying capacity	See Annex B
Stiffness	No performance Assessed
Ductility in cyclic testing	No performance Assessed
3.2 Safety in case of fire (BWR2)	
Reaction to fire	The angle brackets are made from steel classified as Euroclass A1 in accordance with EN 13501-1 and Commission Delegated Regulation 2016/364
3.3 Hygiene, health and the environment (BWR3)	
Influence on air quality	No dangerous materials
3.7 Sustainable use of natural resources (BWR7)	No Performance Assessed
3.8 General aspects related to the performance of the product	The angle brackets have been assessed as having satisfactory durability and serviceability when used in timber structures using the timber species described in Eurocode 5 and subject to the conditions defined by service class 1 and 2
Identification	See Annex A

*) See additional information in section 3.9 – 3.12.

In addition to the specific clauses relating to dangerous substances contained in this European technical Assessment, there may be other requirements applicable to the products falling within its scope (e.g. transposed European legislation and national laws, regulations and administrative provisions). In order to meet the provisions of the Construction Products Regulation, these requirements need also to be complied with, when and where they apply.

3.9 Methods of verification

Safety principles and partial factors

The characteristic load-carrying capacities for angle brackets from steel with thickness 2,5 mm are based on the characteristic values of the nail connections and the steel plates. To obtain design values the capacities have to be multiplied with different partial factors for the material properties, in addition the nail connection with the coefficient k_{mod} .

According to EN 1990 (Eurocode – Basis of design) paragraph 6.3.5 the design value of load-carrying capacity can be determined by reducing the characteristic values of the load-carrying capacity with different partial factors.

Thus, the characteristic values of the load-carrying capacity are determined also for timber failure $F_{Rk,H}$ (obtaining the embedment strength of nails subjected to shear or the withdrawal capacity of the most loaded nail, respectively) as well as for steel plate failure $F_{Rk,S}$. The design value of the load-carrying capacity is the smaller value of both load-carrying capacities.

$$F_{Rd} = \min \left\{ \frac{k_{mod} \cdot F_{Rk,H}}{\gamma_{M,H}}; \frac{F_{Rk,S}}{\gamma_{M,S}} \right\}$$

Therefore, for timber failure the load duration class and the service class are included. The different partial factors γ_M for steel or timber, respectively, are also correctly taken into account.

The characteristic load-carrying capacities for angle brackets from steel with thickness 1,5 mm are based on testing.

As steel and timber failure are both decisive, the design value shall be calculated according to EN 1995-1-1 by reducing the characteristic values of the load-carrying capacity with the partial factor for timber or wood-based materials.

The design value of the load-carrying capacity is:

$$F_{Rd} = \frac{k_{mod} \cdot F_{Rk}}{\gamma_M}$$

3.10 Mechanical resistance and stability

See annex B for the characteristic load-carrying capacity in the different directions F_1 to F_5 .

The characteristic capacities of the angle brackets are determined by calculation assisted by testing as described in the EOTA Guideline 015 clause 5.1.2. They

should be used for designs in accordance with Eurocode 5 or a similar national Timber Code.

The angle brackets in part were calculated for the different load cases with different nail patterns. (see Annex A). For combined loading the following nail patterns shall be used:

Angle Bracket 70 without rib:

F_1 with F_2/F_3 or F_2/F_3 with F_4/F_5 : Nail Patterns F_2/F_3

Angle Bracket 90 with rib:

F_1 with F_2/F_3 or F_2/F_3 with F_4/F_5 : Nail Patterns F_1

Angle Bracket 105 with rib:

F_1 with F_2/F_3 or F_2/F_3 with F_4/F_5 : Nail Patterns F_1

Angle Bracket 105 without rib:

F_1 with F_2/F_3 : Nail Patterns F_2/F_3

Angle Bracket 105 without rib:

F_1 with F_4/F_5 : Nail Patterns F_4/F_5

Threaded nails (ringed shank nails) in accordance to EN 14592

In the formulas in Annex B the capacities for threaded nails calculated from the formulas of Eurocode 5 are used assuming a thick steel plate when calculating the lateral nail load-carrying-capacity.

The load bearing capacities of the brackets has been determined based on the use of connector nails 4,0 x 40 mm in accordance with the German national approval for the nails.

The characteristic withdrawal capacity of the nails has to be determined by calculation in accordance with EN 1995-1-1: 2004, paragraph 8.3.2 (head pull-through is not relevant):

$$F_{ax,Rk} = f_{ax,k} \times d \times t_{pen}$$

Where:

$f_{ax,k}$ Characteristic value of the withdrawal parameter in N/mm^2

d Nail diameter in mm

t_{pen} Penetration depth of the profiles shank in mm
 $t_{pen} \geq 30$ mm

Based on tests by Versuchsanstalt für Stahl, Holz und Steine, University of Karlsruhe, the characteristic value of the withdrawal resistance for the threaded nails used can be calculated as:

$$f_{ax,k} = 50 \times 10^{-6} \times \sigma_k^2$$

Where:

σ_k Characteristic density of the timber in kg/m³

The shape of the nail directly under the head shall be in the form of a truncated cone with a diameter under the nail head which exceeds the hole diameter.

4,0 mm threaded nails with a truncated cone below the head are used as fasteners, which are particularly suitable for nailed steel-to-timber connections. The specific shape below the head causes a clamping of nails in the steel plate.

It is assumed that angle brackets 70 with and without rib are fastened with nails 4,0x40 with a profiled length including the nail point of at least 30 mm and angle brackets 90 and 105 with and without rib are fastened with nails 4,0x60 with a profiled length including the nail point of at least 50 mm.

The design models allow the use of fasteners described in table on page 11 in Annex A

No performance has been assessed in relation to ductility of a joint under cyclic testing. The contribution to the performance of structures in seismic zones, therefore, has not been assessed.

No performance has been assessed in relation to the joint's stiffness properties - to be used for the analysis of the serviceability limit state.

3.11 Aspects related to the performance of the product

3.11.1 Corrosion protection in service class 1 and 2.

In accordance with ETAG 015 the angle brackets are made from pre-galvanized steel S 250 GD + Z 275 according to EN 10346.

3.12 General aspects related to the fitness for use of the product

The angle brackets are manufactured in accordance with the provisions of this European Technical Assessment using the manufacturing processes as identified in the inspection of the plant by the notified inspection body and laid down in the technical documentation

The nailing pattern used shall be either the maximum or the minimum pattern as defined in Annex A.

The following provisions concerning installation apply:

The structural members – the components 1 and 2

shown in the figure on page 18 - to which the brackets are fixed shall be:

- Restrained against rotation. At a load F_4/F_5 , the component 2 is allowed to be restrained against rotation by the Angle brackets.
- Strength class C14 or better, see section 1 of this ETA
- Free from wane under the bracket.
- The actual end bearing capacity of the timber member to be used in conjunction with the bracket is checked by the designer of the structure to ensure it is not less than the bracket capacity and, if necessary, the bracket capacity reduced accordingly.
- The gap between the timber members does not exceed 3 mm.
- There are no specific requirements relating to preparation of the timber members.

The execution of the connection shall be in accordance with the approval holder's technical literature.

4 Attestation and verification of constancy of performance (AVCP)

4.1 AVCP system

According to the decision 97/638/EC of the European Commission¹, as amended, the system(s) of assessment and verification of constancy of performance (see Annex V to Regulation (EU) No 305/2011) is 2+.

5 Technical details necessary for the implementation of the AVCP system, as foreseen in the applicable EAD

Technical details necessary for the implementation of the AVCP system are laid down in the control plan deposited at ETA-Danmark prior to CE marking.

Issued in Copenhagen on 2018-09-06



Thomas Bruun
Manager, ETA-Danmark

Annex A
Product details

Product details definitions

Table A.1 Materials specification

Bracket type	Thickness (mm)	Steel specification	Coating specification
70 with rib	2,5	S 250 GD + Z 275	Z 275
70 without rib	2,5	S 250 GD + Z 275	Z 275
90 with rib	2,5	S 250 GD + Z 275	Z 275
90 without rib	2,5	S 250 GD + Z 275	Z 275
105 with rib	3,0	S 250 GD + Z 275	Z 275
105 without rib	3,0	S 250 GD + Z 275	Z 275

Bracket type	Thickness (mm)	Steel specification	Coating specification
70 with rib	1,5	S 250 GD + Z 275	Z 275
90 with rib	1,5	S 250 GD + Z 275	Z 275
105 with rib	1,5	S 250 GD + Z 275	Z 275

Table A.2 Range of sizes, 2,5 mm thick

Bracket type	Height (mm)		Width (mm)	
	min	max	min	max
70 with rib	70	70	52	55
70 without rib	70	70	55	55
90 with rib	90	90	62	65
90 without rib	90	90	65	65
105 with rib	105	105	90	90
105 without rib	105	105	90	90

Table A.3 Range of sizes, 1,5 mm thick

Bracket type	Height (mm)		Width (mm)	
	min	max	min	max
70 with rib	69	71	52	55
90 with rib	89	91	62	65
105 with rib	104	106	87	90

Table A.3 Fastener specification

NAIL diameter	Length Min – max	Nail type
4.0	60 - 100	Ringed shank nails according to EN 14592
<p>The load-carrying capacities of the angle brackets were determined based on the use of connector nails 4,0 x 60 mm in accordance with the German national approval for the nails. The characteristic withdrawal capacity of the nails has to be determined by calculation in accordance with EN 1995-1-1: 2004, paragraph 8.3.2 (head pull-through is not relevant):</p> $F_{ax,Rk} = f_{1,k} \times d \times t_{pen}$ <p>Where:</p> <p>$f_{1,k}$ Characteristic value of the withdrawal parameter in N/mm² d Nail diameter in mm t_{pen} Penetration depth of the profiled shank in mm</p> <p>Based on tests by Versuchsanstalt für Stahl, Holz und Steine, University of Karlsruhe, the characteristic value of the withdrawal resistance for the threaded nails used can be calculated as:</p> $f_{1,k} = 50 \times 10^{-6} \times \rho_k^2$ <p>Where:</p> <p>ρ_k Characteristic density of the timber in kg/m³</p> <p>The shape of the nail directly under the head shall be in the form of a truncated cone with a diameter under the nail head which exceeds the hole diameter.</p>		

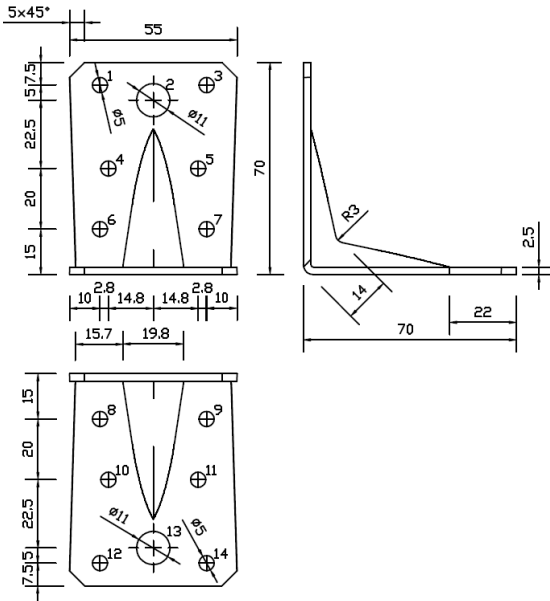

Figure A.1 Dimensions of Angle Bracket 70 with rib

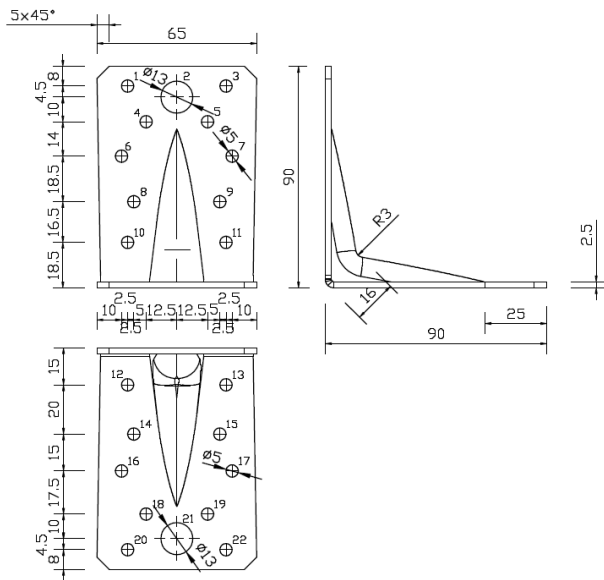
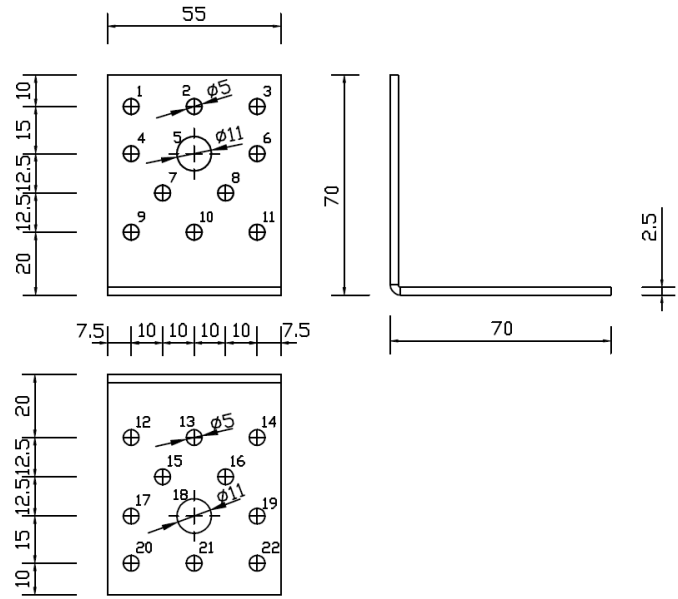

Figure A.3 Dimensions of Angle Bracket 90 with rib

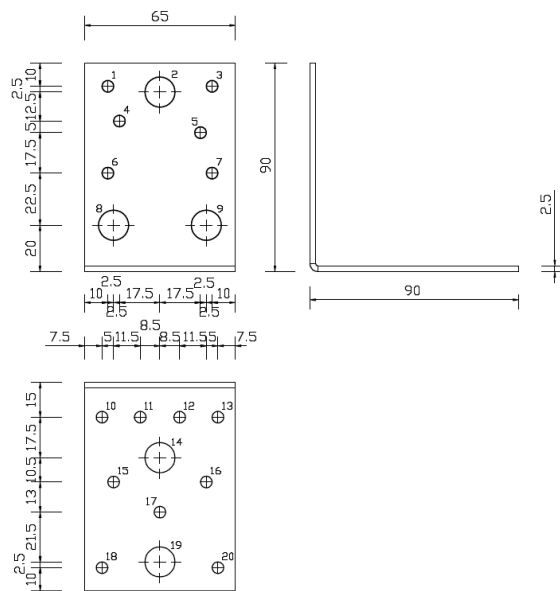

Figure A.4 Dimensions of Angle Bracket 90 without rib

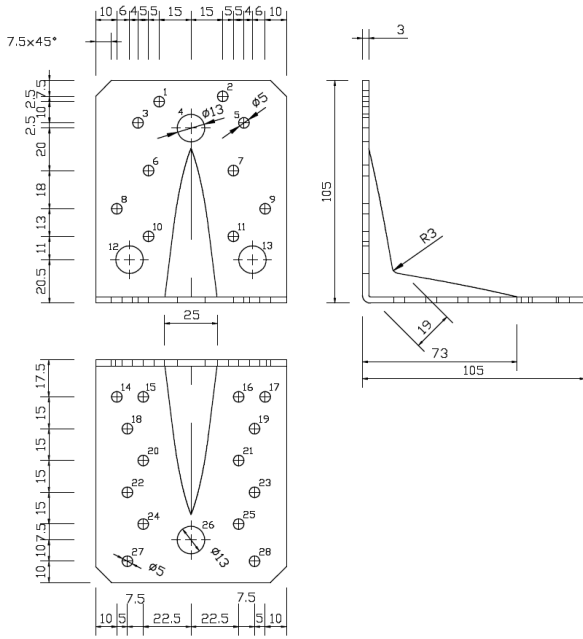

Figure A.5 Dimensions of Angle Bracket 105 with rib

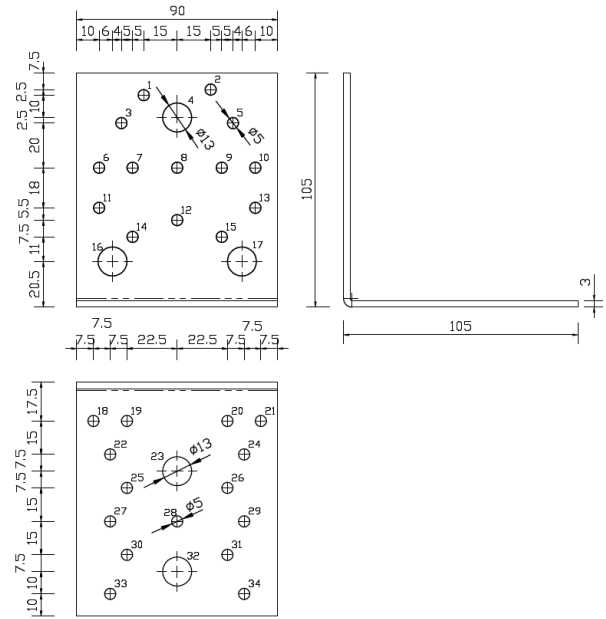

Figure A.6 Dimensions of Angle Bracket 105 without rib

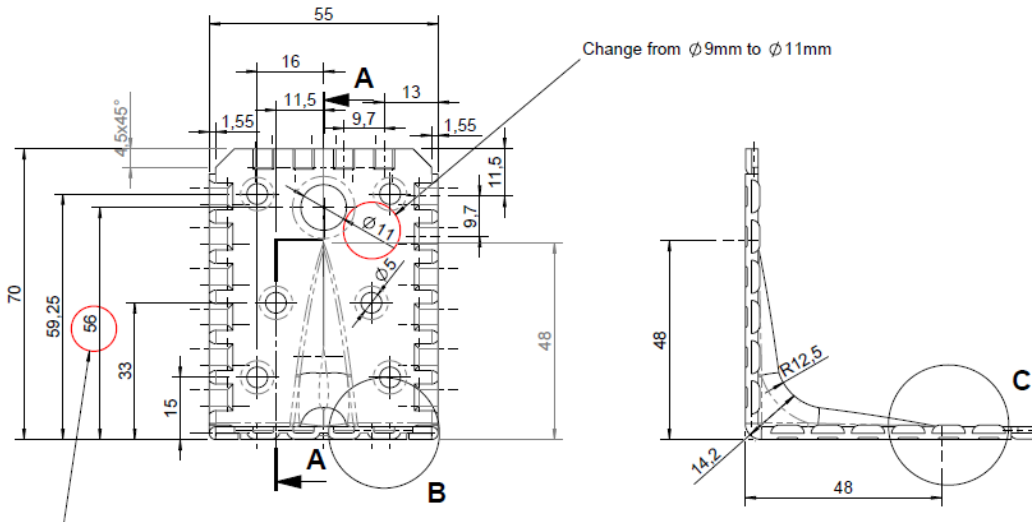

Figure A.7 Dimensions of Angle Bracket 70 with rib, thickness 1,5 mm

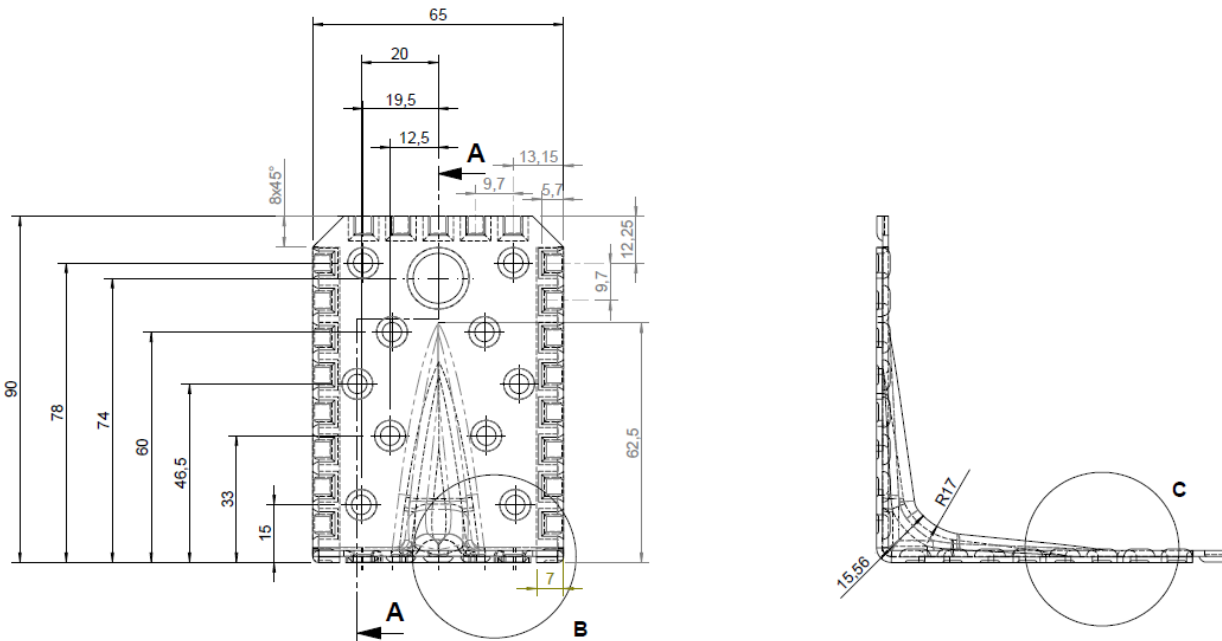
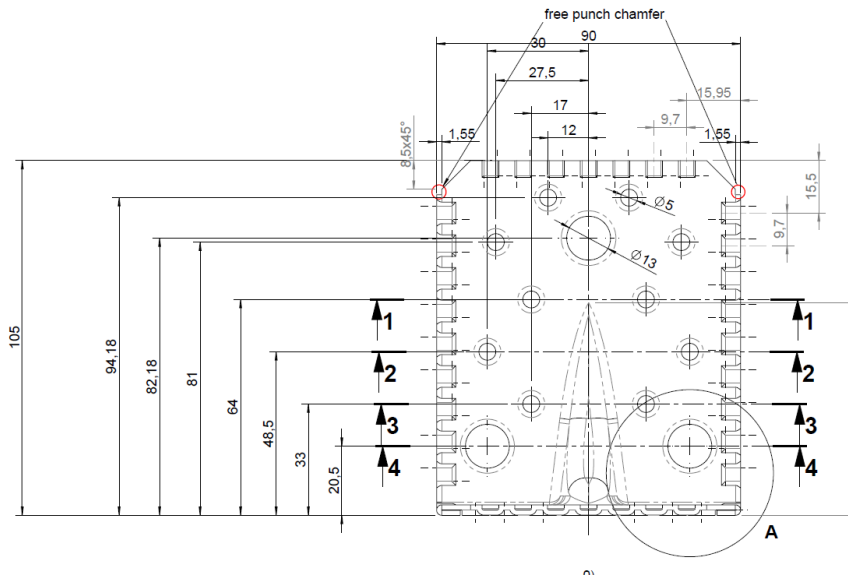

Figure A.8 Dimensions of Angle Bracket 90 with rib, thickness 1,5 mm



Seitenansicht von Links

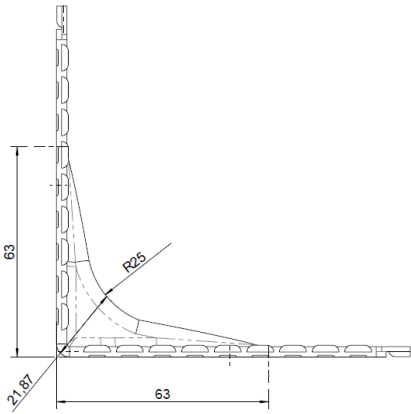

Figure A.9 Dimensions of Angle Bracket 105 with rib, thickness 1,5 mm

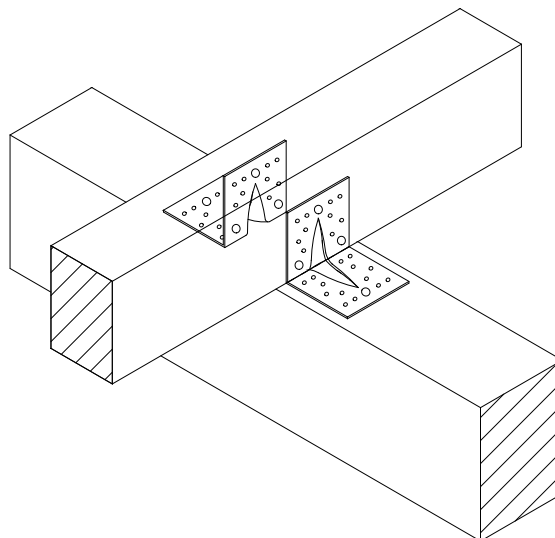
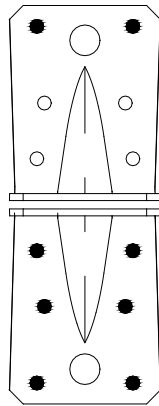

Figure A.10 Typical installation

Nail Patterns – Angle Bracket 70 with rib

LC 1 – column

Nails in hole number:
1,3 /
8,9,10,11,12,14



LC 1 – purlin

Nails in hole number:
1,3,4,5 /
8,9,10,11,12,14

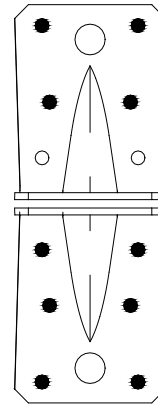

LC 2/3

Nails in hole number:
1,3,4,5 /
8,9,10,11,12,14

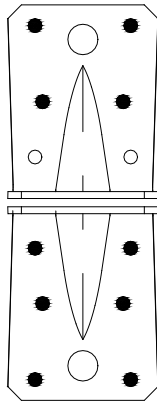

LC 4/5

Nails in hole number:
1,3,4,5 /
8,9,10,11,12,14

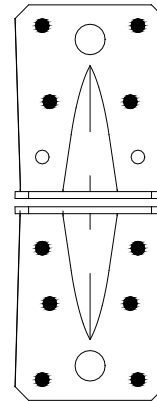

Nail Patterns – Angle Bracket 70 without rib

LC 1 – column

Nails in hole number:
1,2,3 /
12,13,14,20,21,22

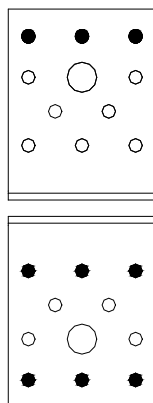

LC 1 – purlin

Nails in hole number:
1,2,3,4,6,7,8 /
12,13,14,20,21,22

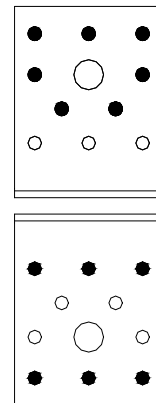

Nail Patterns – Angle Bracket 70 without rib

LC 2/3

Nails in hole number:
1,3,4,6,9,11 /
12,13,14,20,21,22

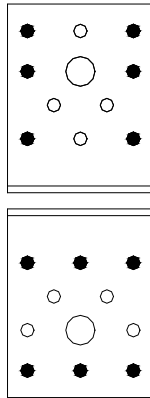

LC 4/5

Nails in hole number:
1,2,3,4,6,7,8 /
12,13,14,20,21,22

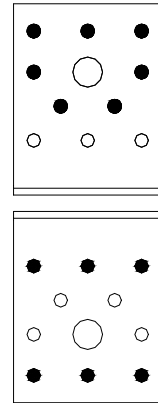

Nail Patterns – Angle Bracket 90 with rib

LC 1 – column

Nails in hole number:
1,3,6,7/
12,13,14,15,18,19

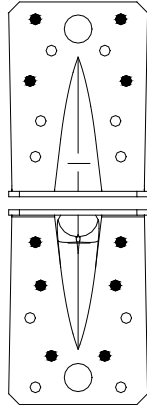

LC 1 – purlin

Nails in hole number:
1,3,4,5,6,7,8,9 /
12,13,14,15,18,19

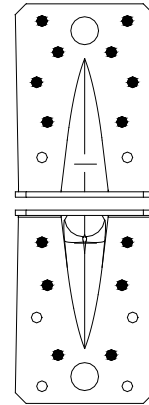

LC 2/3

Nails in hole number:
1,3,6,7,8,9 /
12,13,16,17,20,22

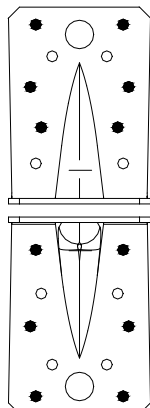

LC 4/5

Nails in hole number:
1,3,4,5,6,7,8,9 /
12,13,14,15,18,19

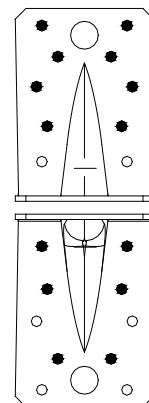

Nail Patterns – Angle Bracket 90 without rib

LC 1 – column

Nails in hole number:
1,3,5/
10,11,12,13,15,16
17,18,20

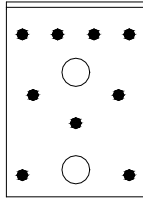
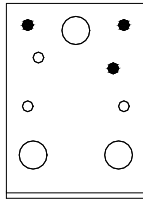

LC 1 – purlin

Nails in hole number:
1,3,4,5,6,7/
10,11,12,13,,15,16
17,18,20

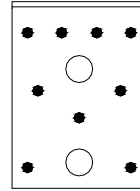
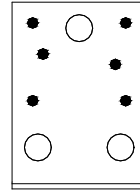

LC 2/3

Nails in hole number:
1,3,6,7,8,9 /
12,13,16,17,20,22

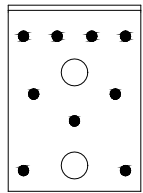
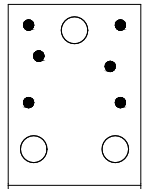

LC 4/5

Nails in hole number:
1,3,4,5,6,7,8,9 /
12,13,14,15,18,19

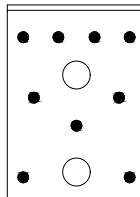
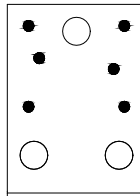

Nail Patterns – Angle Bracket 105 with rib

LC 1 – column

Nails in hole number:
1,2,6,7 /
14,15,16,17,20,21,24,25

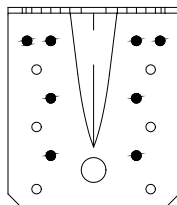
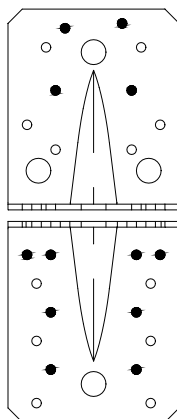

LC 1 – purlin

Nails in hole number:
1,2,3,5,6,7,8,9,10,11 /
14,15,16,17,20,21,24,25

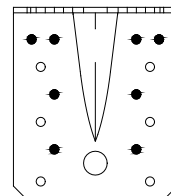
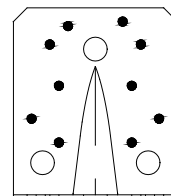

Nail Patterns – Angle Bracket 105 with rib

LC 2/3

Nails in hole number:
1,2,6,7,10,11 /
14,15,16,17,22,23,27,28

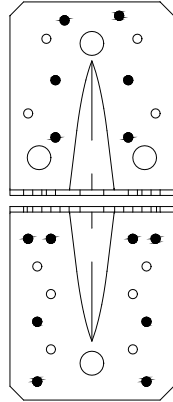

LC 4/5

Nails in hole number:
1,2,3,5,6,7,8,9,10,11 /
14,15,16,17,20,21,24,25

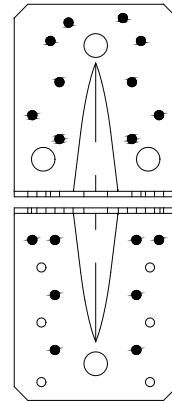

Nail Patterns – Angle Bracket 105 without rib

LC 1 – column

Nails in hole number:
1,2,6,7,8,9,10
18,19,20,21,25,26,30,31

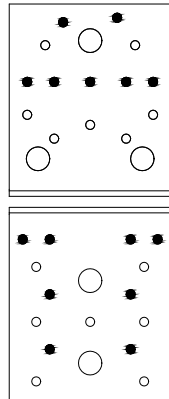

LC 1 – purlin

Nails in hole number:
1,2,3,5,6,8,10,12,14,15 /
18,19,20,21,25,26,30,31

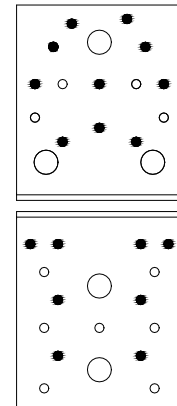

LC 2/3

Nails in hole number:
1,2,6,8,10,11,13,14,15 /
18,19,20,21,27,28,29,33,34

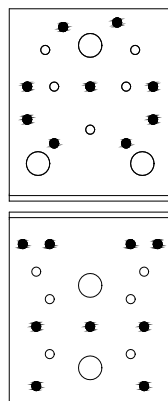

LC 4/5

Nails in hole number:
1,2,3,5,6,8,10,12,14,15 /
18,19,20,21,27,28,29,33,34

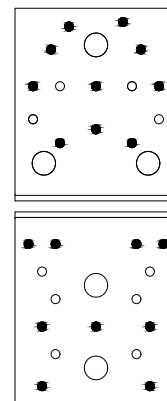

Annex B
Characteristic load-carrying capacities – brackets 2,5 mm thickness

Definitions of forces, their directions and eccentricity

Forces - Beam to beam connection

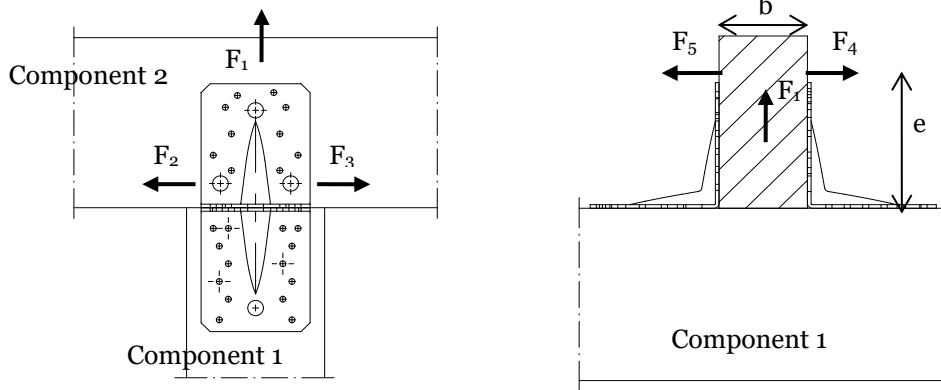

Fastener specification

Holes are marked with numbers referring to the nailing pattern in Annex A.

The holes which have to be nailed are given in Annex A for the different forces. If a connection is subjected to combined loading the following nail patterns have to be used:

Angle Bracket 70 without rib:	F_1 with F_2/F_3 or F_2/F_3 with F_4/F_5 :	Nail Patterns F_2/F_3
Angle Bracket 90 with rib:	F_1 with F_2/F_3 or F_2/F_3 with F_4/F_5 :	Nail Patterns F_1
Angle Bracket 105 with rib:	F_1 with F_2/F_3 or F_2/F_3 with F_4/F_5 :	Nail Patterns F_1
Angle Bracket 105 without rib:	F_1 with F_2/F_3 :	Nail Patterns F_2/F_3
Angle Bracket 105 without rib:	F_1 with F_4/F_5 :	Nail Patterns F_4/F_5

Double angle brackets per connection

The angle brackets must be placed at each side opposite each other, symmetric to the component axis.

Acting forces

- F_1 Lifting force acting along the central axis of the joint.
- F_2 and F_3 Lateral force acting in the joint between the component 2 and component 1 in the component 2 direction
- F_4 and F_5 Lateral force acting in the component 1 direction along the central axis of the joint. If the load is applied with an eccentricity e , a design for combined loading is required.

Single angle bracket per connection

Acting forces

- F_1 Lifting force acting in the central axis of the angle bracket. The component 2 shall be prevented from rotation. If the component 2 is prevented from rotation the load-carrying capacity will be half of a connection with double angle brackets.
- F_2 and F_3 Lateral force acting in the joint between the component 2 and the component 1 in the component 2 direction. The component 2 shall be prevented from rotation. If the component 2 is prevented from rotation the load-carrying capacity will be half of a connection with double angle brackets.
- F_4 and F_5 Lateral force acting in the component 1 direction in the height of the top edge of component 2. F_4 is the lateral force towards the angle bracket; F_5 is the lateral force away from the angle bracket. Only the characteristic load-carrying capacities for angle brackets with ribs are given.

Wane

Wane is not allowed, the timber has to be sharp-edged in the area of the angle brackets.

Timber splitting

For the lifting force F_1 it must be checked in accordance with Eurocode 5 or a similar national Timber Code that splitting will not occur.

Combined forces

If the forces F_1 and F_2/F_3 or F_4/F_5 act at the same time, the following inequality shall be fulfilled:

$$\left(\frac{F_{1,d}}{F_{Rd,1}}\right)^2 + \left(\frac{F_{2,d}}{F_{Rd,2}}\right)^2 + \left(\frac{F_{3,d}}{F_{Rd,3}}\right)^2 + \left(\frac{F_{4,d}}{F_{Rd,4}}\right)^2 + \left(\frac{F_{5,d}}{F_{Rd,5}}\right)^2 \leq 1$$

The forces F_2 and F_3 or F_4 and F_5 are forces with opposite direction. Therefore only one force F_2 or F_3 , respectively, and F_4 or F_5 , respectively, is able to act simultaneously with F_1 , while the other shall be set to zero.

If the load F_4/F_5 is applied with an eccentricity e , a design for combined loading **for connections with double angle brackets** is required. Here, an additional force ΔF_1 has to be added to the existing force F_1 .

$$\Delta F_{1,d} = F_{4,d} / F_{5,d} \cdot \frac{e}{B}$$

B is the width of component 2.

Characteristic load-carrying capacities 2 angle brackets per connection

Table B.1: Characteristic load-carrying capacities Load F_1 – 2 angle brackets / connection

Angle Bracket	Nail number n_v	Nail number n_h	Timber $R_{Rk,H}$	Steel $R_{Rk,S}$
70 without rib	1,2,3	12,13,14,20,21,22	3,05 kN	1,56 kN
90 without rib	1,3,5	10,11,12,13,15,16,17,18,20	8,07 kN	2,34 kN
105 without rib	1,2,6,7,8,9,10	18,19,20,21,25,26,30,31	8,09 kN	4,50 kN
70 with rib	1,3	8,9,10,11,12,14	3,16 kN	4,57 kN
90 with rib	1,3,6,7	12,13,14,15,18,19	6,46 kN	8,59 kN
105 with rib	1,2,6,7	14,15,16,17,20,21,24,25	11,8 kN	14,0 kN
Angle bracket 70 with and without rib are connected with nails $\phi 4,0 \times 40$				
Angle bracket 90 and 105 with and without rib are connected with nails $\phi 4,0 \times 60$				

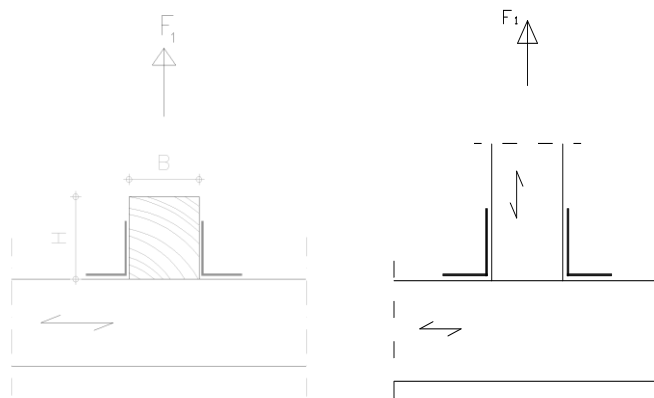

Table B.2: Characteristic load-carrying capacities Load $F_{2/3}$, 2 angle brackets / connection

Angle Bracket	Nail number n_v	Nail number n_h	Timber $R_{Rk,H}$
70 without rib	1,3,4,6,9,11	12,13,14,20,21,22	7,57 kN
90 without rib	1,3,4,5,6,7	10,11,12,13,15,16,17,18,20	9,55 kN
105 without rib	1,2,6,8,10,11,13, 14,15	18,19,20,21,27,28,29,33,34	12,8 kN
70 with rib	1,3,4,5	8,9,10,11,12,14	5,49 kN
90 with rib	1,3,6,7,8,9	12,13,16,17,20,22	8,39 kN
105 with rib	1,2,6,7,10,11	14,15,16,17,22,23,27,28	9,60 kN
Angle bracket 70 with and without rib are connected with nails $\phi 4,0 \times 40$			
Angle bracket 90 and 105 with and without rib are connected with nails $\phi 4,0 \times 60$			

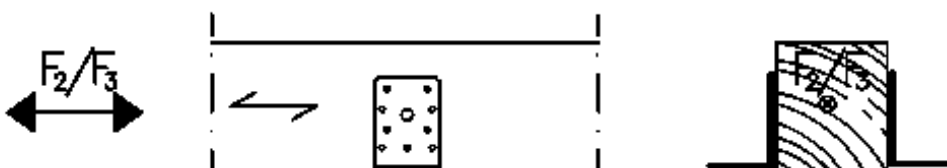
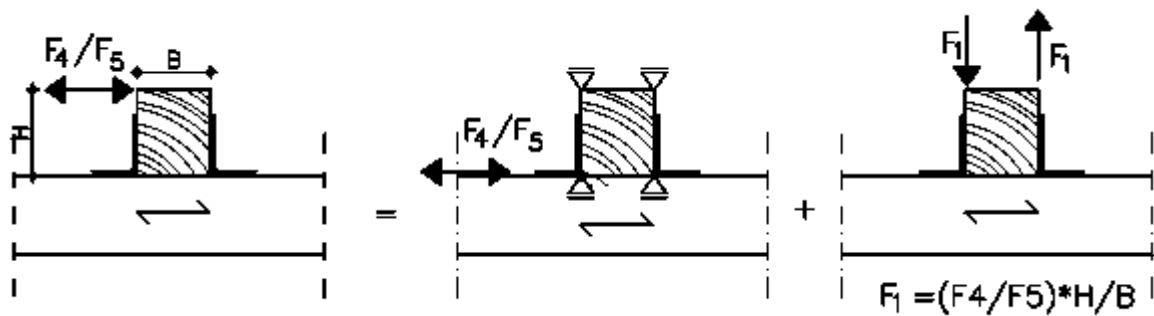

Table B.3: Characteristic load-carrying capacities Load $F_{4/5}$, 2 angle brackets / connection

Angle Bracket	Nail number n_v	Nail number n_h	Timber $R_{Rk,H}$	Steel $R_{Rk,S}$
70 without rib	1,2,3,4,6,7,8,	12,13,14,20,21,22	6,10 kN	3,63 kN
90 without rib	1,3,4,5,6,7	10,11,12,13,15,16,17,18,20	9,67 kN	3,99 kN
105 without rib	1,2,3,5,6,8,10,12,14,15	18,19,20,21,27,28,29,33,34	10,6 kN	7,98 kN
70 with rib	1,3,4,5	8,9,10,11,12,14	5,65 kN	4,12 kN
90 with rib	1,3,4,5,6,7,8,9	12,13,14,15,18,19	8,91 kN	6,55 kN
105 with rib	1,2,3,5,6,7,8,9,10,11	14,15,16,17,20,21,24,25	11,9 kN	11,8 kN

Angle bracket 70 with and without rib are connected with nails $\phi 4,0 \times 40$

Angle bracket 90 and 105 with and without rib are connected with nails $\phi 4,0 \times 60$



Characteristic load-carrying capacities with one angle bracket per connection**The force F_4 , respectively F_5 , is applied on the upper beam edge.****Table B.4:** Characteristic load-carrying capacities ($R_{Rk,H} / R_{Rk,S}$) Load F_4 (Force towards the angle bracket)

	H in m					
	0,08	0,10	0,12	0,14	0,16	0,20
70 with rib	0,82 kN/0,38 kN	0,66 kN/0,28 kN	-	0,47 kN/0,21 kN	-	-
90 with rib	-	-	1,11 kN/0,46 kN	0,95 kN/0,40 kN	0,84 kN/0,35 kN	-
105 with rib	-	-	2,42 kN/1,02 kN	-	1,82 kN/0,69 kN	1,37 kN/0,52 kN

Table B.5: Characteristic load-carrying capacities ($R_{Rk,H} / R_{Rk,S}$) Load F_5 (Force off the angle bracket)

70 with rib	H in m		
B in m	0,08	0,10	0,14
0,06	1,58 kN ; 0,93 kN	1,73 kN ; 1,12 kN	2,45 kN ; 1,06 kN
0,10	1,44 kN ; 1,30 kN	1,58 kN ; 1,19 kN	1,56 kN ; 1,26 kN
0,14	1,45 kN ; 1,29 kN	1,47 kN ; 1,28 kN	1,48 kN ; 1,26 kN

Table B.6: Characteristic load-carrying capacities ($R_{Rk,H} / R_{Rk,S}$) Load F_5 (Force off the angle bracket)

90 with rib	H in m		
B in m	0,12	0,14	0,16
0,08	3,85 kN ; 1,83 kN	4,24 kN ; 1,72 kN	4,89 kN ; 1,62 kN
0,10	3,49 kN ; 1,98 kN	3,65 kN ; 1,90 kN	3,88 kN ; 1,82 kN
0,14	3,23 kN ; 2,12 kN	3,30 kN ; 2,08 kN	3,37 kN ; 2,03 kN

Table B.7: Characteristic load-carrying capacities ($R_{Rk,H} / R_{Rk,S}$) Load F_5 (Force off the angle bracket)

105 with rib	H in m		
B in m	0,12	0,16	0,20
0,08	5,94 kN ; 3,14 kN	5,45 kN ; 2,67 kN	4,68 kN ; 2,30 kN
0,10	5,24 kN ; 3,55 kN	6,09 kN ; 3,13 kN	5,27 kN ; 2,80 kN
0,14	4,68 kN ; 3,99 kN	5,00 kN ; 3,72 kN	5,35 kN ; 3,47 kN

Annex C
Characteristic load-carrying capacities – brackets 1,5 mm thickness

Definitions of forces, their directions and eccentricity

Forces - Beam to beam connection

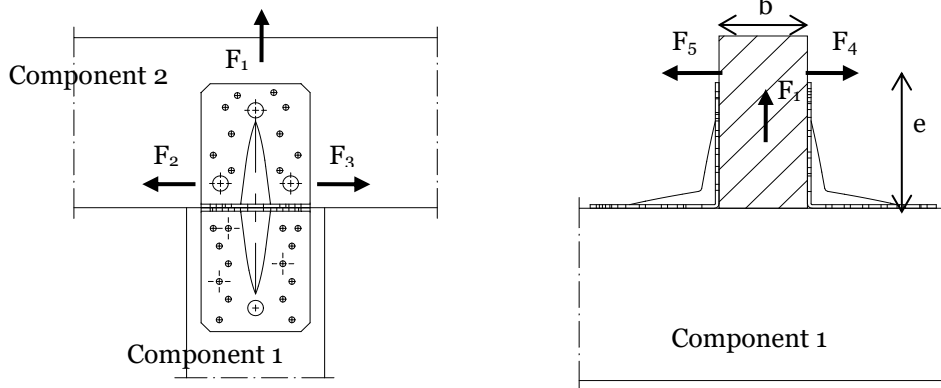

Fastener specification

A full nailing pattern is specified, where there are nails in all nail holes.

Double angle brackets per connection

The angle brackets must be placed at each side opposite each other, symmetric to the component axis.

Acting forces

- F_1 Lifting force acting along the central axis of the joint.
- F_{23} Lateral force acting in the joint between the component 2 and component 1 in the component 2 direction
- F_{45} Lateral force acting in the component 1 direction along the central axis of the joint. If the load is applied with an eccentricity e , a design for combined loading is required.

Single angle bracket per connection

Acting forces

- F_1 Lifting force acting in the central axis of the angle bracket. The component 2 shall be prevented from rotation. If the component 2 is prevented from rotation the load-carrying capacity will be half of a connection with double angle brackets.
- F_2 and F_3 Lateral force acting in the joint between the component 2 and the component 1 in the component 2 direction. The component 2 shall be prevented from rotation. If the component 2 is prevented from rotation the load-carrying capacity will be half of a connection with double angle brackets.

Wane

Wane is not allowed, the timber has to be sharp-edged in the area of the angle brackets.

Timber splitting

For the lifting force F_1 it must be checked in accordance with Eurocode 5 or a similar national Timber Code that splitting will not occur.

Combined forces

If the forces F_1 and F_2/F_3 or F_4/F_5 act at the same time, the following inequality shall be fulfilled:

$$\left(\frac{F_{1,Ed}}{F_{1,Rd}} \right)^2 + \left(\frac{F_{23,Ed}}{F_{23,Rd}} \right)^2 + \left(\frac{F_{45,Ed}}{F_{45,Rd}} \right)^2 \leq 1$$

If the load F_{45} is applied with an eccentricity e , a design for combined loading for connections with double angle brackets is required. Here, an additional force ΔF_1 has to be added to the existing force F_1 .

$$\Delta F_{1,d} = F_{4,d} / F_{5,d} \cdot \frac{e}{B}$$

B is the width of component 2.

Characteristic load-carrying capacities 2 angle brackets per connection

Table C.1: Characteristic load-carrying capacities Load F_1 – 2 angle brackets / connection

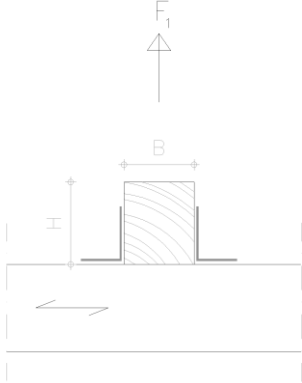
Angle Bracket	$F_{1,Rk}$	
70 with rib	10,8 kN	
90 with rib	9,8 kN	
105 with rib	18,4 kN	

Table C.2: Characteristic load-carrying capacities Load F_{23} , 2 angle brackets / connection

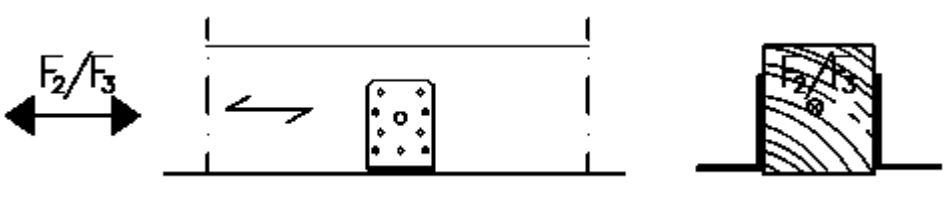
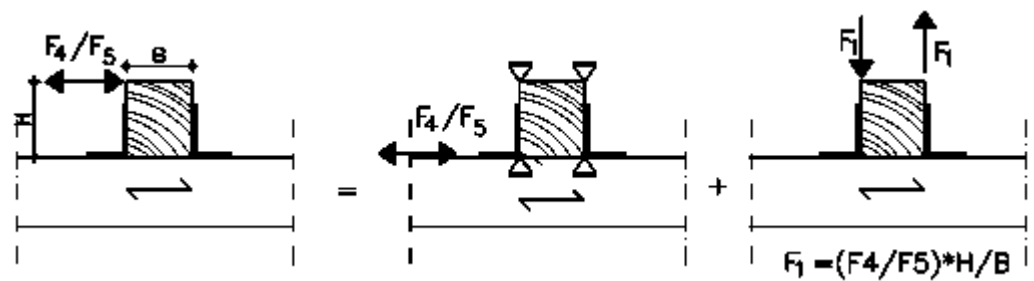
Angle Bracket	$F_{23,Rk}$	
70 with rib	12,7 kN	
90 with rib	12,2 kN	
105 with rib	17,0 kN	

Table C.3: Characteristic load-carrying capacities Load F_{45} , 2 angle brackets / connection

Angle Bracket	$F_{45,Rk}$	
70 with rib	11,0 kN	
90 with rib	13,5 kN	
105 with rib	16,4 kN	